

# Am2901

Four-Bit Bipolar Microprocessor Slice  
Advanced Micro Devices  
Bipolar Microprocessor Circuits



## DISTINCTIVE CHARACTERISTICS

- Two-address architecture – Independent simultaneous access to two working registers saves machine cycles.
- Eight-function ALU – Performs addition, two subtraction operations, and five logic functions on two source operands.
- Flexible data source selection – ALU data is selected from five source ports for a total of 203 source operand pairs for every ALU function.
- Left/right shift independent of ALU – Add and shift operations take only one cycle.
- Four status flags – Carry, overflow, zero, and negative.
- Expandable – Connect any number of Am2901's together for longer word lengths.
- Microprogrammable – Three groups of three bits each for source operand, ALU function, and destination control.

## GENERAL DESCRIPTION

The four-bit bipolar microprocessor slice is designed as a high-speed cascadable element intended for use in CPU's, peripheral controllers, programmable microprocessors and numerous other applications. The microinstruction flexibility of the Am2901 will allow efficient emulation of almost any digital computing machine.

The device, as shown in the block diagram below, consists of a 16-word by 4-bit two-port RAM, a high-speed ALU, and the associated shifting, decoding and multiplexing circuitry. The nine-bit microinstruction word is organized into three groups of three bits each and selects the ALU source operands, the ALU function, and the ALU destination register. The microprocessor is cascadable with full look-ahead or with ripple carry, has three-state outputs, and provides various status flag outputs from the ALU. Advanced low-power Schottky processing is used to fabricate this 40-lead LSI chip.

## TABLE OF CONTENTS

Block Diagram . . . . .	4
Function Tables . . . . .	5
Package Outline . . . . .	7
Connection Diagram . . . . .	8
Pin Definitions . . . . .	8
Screening . . . . .	9
Order Codes . . . . .	9
DC Characteristics . . . . .	10
AC Characteristics . . . . .	11
Switching Waveforms . . . . .	12
Applications . . . . .	13

## MICROPROCESSOR SLICE BLOCK DIAGRAM

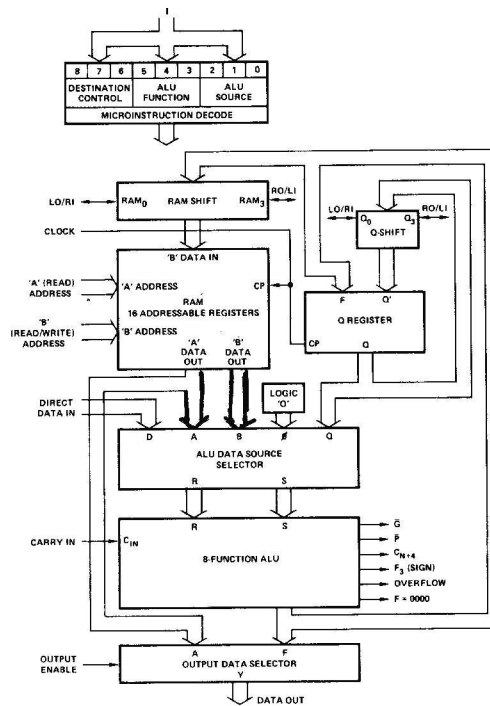

## ARCHITECTURE

A detailed block diagram of the bipolar microprogrammable microprocessor structure is shown in Figure 1. The circuit is a four-bit slice cascadable to any number of bits. Therefore, all data paths within the circuit are four bits wide. The two key elements in the Figure 1 block diagram are the 16-word by 4-bit 2-port RAM and the high-speed ALU.

Data in any of the 16 words of the Random Access Memory (RAM) can be read from the A-port of the RAM as controlled by the 4-bit A address field input. Likewise, data in any of the 16 words of the RAM as defined by the B address field input can be simultaneously read from the B-port of the RAM. The same code can be applied to the A select field and B select field in which case the identical file data will appear at both the RAM A-port and B-port outputs simultaneously.

When enabled by the RAM write enable (RAM EN), new data is always written into the file (word) defined by the B address field of the RAM. The RAM data input field is driven by a 3-input multiplexer. This configuration is used to shift the ALU output data (F) if desired. This three-input multiplexer scheme allows the data to be shifted up (right) one bit position, shifted down (left) one bit position, or not shifted in either direction.

The RAM A-port data outputs and RAM B-port data outputs drive separate 4-bit latches. These latches hold the RAM data while the clock input is LOW. This eliminates any possible race conditions that could occur while new data is being written into the RAM.

The high-speed Arithmetic Logic Unit (ALU) can perform three binary arithmetic and five logic operations on the two 4-bit input words R and S. The R input field is driven from a 2-input multiplexer, while the S input field is driven from a 3-input multiplexer. Both multiplexers also have an inhibit capability; that is, no data is passed. This is equivalent to a "zero" source operand.

Referring to Figure 1, the ALU R-input multiplexer has the RAM A-port and the direct data inputs (D) connected as inputs. Likewise, the ALU S-input multiplexer has the RAM A-port, the RAM B-port and the Q register connected as inputs.

This multiplexer scheme gives the capability of selecting various pairs of the A, B, D, Q and "0" inputs as source operands to the ALU. These five inputs, when taken two at a time, result in ten possible combinations of source operand pairs. These combinations include AB, AD, AQ, AO, BD, BQ, BO, DQ, DO and QO. It is apparent that AD, AQ and AO are somewhat redundant with BD, BQ and BO in that if the A address and B address are the same, the identical function results. Thus, there are only seven completely non-redundant source operand pairs for the ALU. The Am2901 microprocessor implements eight of these pairs. The microinstruction inputs used to select the ALU source operands are the I<sub>0</sub>, I<sub>1</sub>, and I<sub>2</sub> inputs. The definition of I<sub>0</sub>, I<sub>1</sub>, and I<sub>2</sub> for the eight source operand combinations are as shown in Figure 2. Also shown is the octal code for each selection.

The two source operands not fully described as yet are the D input and Q input. The D input is the four-bit wide direct data field input. This port is used to insert all data into the working registers inside the device. Likewise, this input can be used in the ALU to modify any of the internal data files. The Q register is a separate 4-bit file intended primarily for multiplication and division routines but it can also be used as an accumulator or holding register for some applications.

The ALU itself is a high-speed arithmetic/logic operator capable of performing three binary arithmetic and five logic functions. The I<sub>3</sub>, I<sub>4</sub>, and I<sub>5</sub> microinstruction inputs are used to select the

ALU function. The definition of these inputs is shown in Figure 3. The octal code is also shown for reference. The normal technique for cascading the ALU of several devices is in a look-ahead carry mode. Carry generate,  $\bar{G}$ , and carry propagate,  $\bar{P}$ , are outputs of the device for use with a carry-look-ahead-generator such as the Am2902 ('182). A carry-out, C<sub>n+4</sub>, is also generated and is available as an output for use as the carry flag in a status register. Both carry-in (C<sub>n</sub>) and carry-out (C<sub>n+4</sub>) are active HIGH.

The ALU has three other status-oriented outputs. These are F<sub>3</sub>, F = 0, and overflow (OVR). The F<sub>3</sub> output is the most significant (sign) bit of the ALU and can be used to determine positive or negative results without enabling the three-state data outputs. F<sub>3</sub> is non-inverted with respect to the sign bit output Y<sub>3</sub>. The F = 0 output is used for zero detect. It is an open-collector output and can be wire OR'ed between microprocessor slices. F = 0 is HIGH when all F outputs are LOW. The overflow output (OVR) is used to flag arithmetic operations that exceed the available two's complement number range. The overflow output (OVR) is HIGH when overflow exists. That is, when C<sub>n+3</sub> and C<sub>n+4</sub> are not the same polarity.

The ALU data output is routed to several destinations. It can be a data output of the device and it can also be stored in the RAM or the Q register. Eight possible combinations of ALU destination functions are available as defined by the I<sub>6</sub>, I<sub>7</sub>, and I<sub>8</sub> microinstruction inputs. These combinations are shown in Figure 4.

The four-bit data output field (Y) features three-state outputs and can be directly bus organized. An output control ( $\bar{OE}$ ) is used to enable the three-state outputs. When  $\bar{OE}$  is HIGH, the Y outputs are in the high-impedance state.

A two-input multiplexer is also used at the data output such that either the A-port of the RAM or the ALU outputs (F) are selected at the device Y outputs. This selection is controlled by the I<sub>6</sub>, I<sub>7</sub>, and I<sub>8</sub> microinstruction inputs. Refer to Figure 4 for the selected output for each microinstruction code combination.

As was discussed previously, the RAM inputs are driven from a three-input multiplexer. This allows the ALU outputs to be entered non-shifted, shifted up one position (X2) or shifted down one position ( $\div 2$ ). The shifter has two ports; one is labeled RAM<sub>0</sub>-LO/RI and the other is labeled RAM<sub>3</sub>-RO/LI. Both of these ports consist of a buffer-driver with a three-state output and an input to the multiplexer. Thus, in the shift up mode, the RO buffer is enabled and the RI multiplexer input is enabled. Likewise, in the shift down mode, the LO buffer and LI input are enabled. In the no-shift mode, both the LO and RO buffers are in the high-impedance state and the multiplexer inputs are not selected. This shifter is controlled from the I<sub>6</sub>, I<sub>7</sub>, and I<sub>8</sub> microinstruction inputs as defined in Figure 4.

Similarly, the Q register is driven from a 3-input multiplexer. In the no-shift mode, the multiplexer enters the ALU data into the Q register. In either the shift-up or shift-down mode, the multiplexer selects the Q register data appropriately shifted up or down. The Q shifter also has two ports; one is labeled Q<sub>0</sub>-LO/RI and the other is Q<sub>3</sub>-RO/LI. The operation of these two ports is similar to the RAM shifter and is also controlled from I<sub>6</sub>, I<sub>7</sub>, and I<sub>8</sub> as shown in Figure 4.

The clock input to the Am2901 controls the RAM, the Q register, and the A and B data latches. When enabled, data is clocked into the Q register on the LOW-to-HIGH transition of the clock. When the clock input is HIGH, the A and B latches are open and will pass whatever data is present at the RAM outputs. When the clock input is LOW, the latches are closed and will retain the last data entered. If the RAM-EN is enabled, new data will be written into the RAM file (word) defined by the B address field when the clock input is LOW.

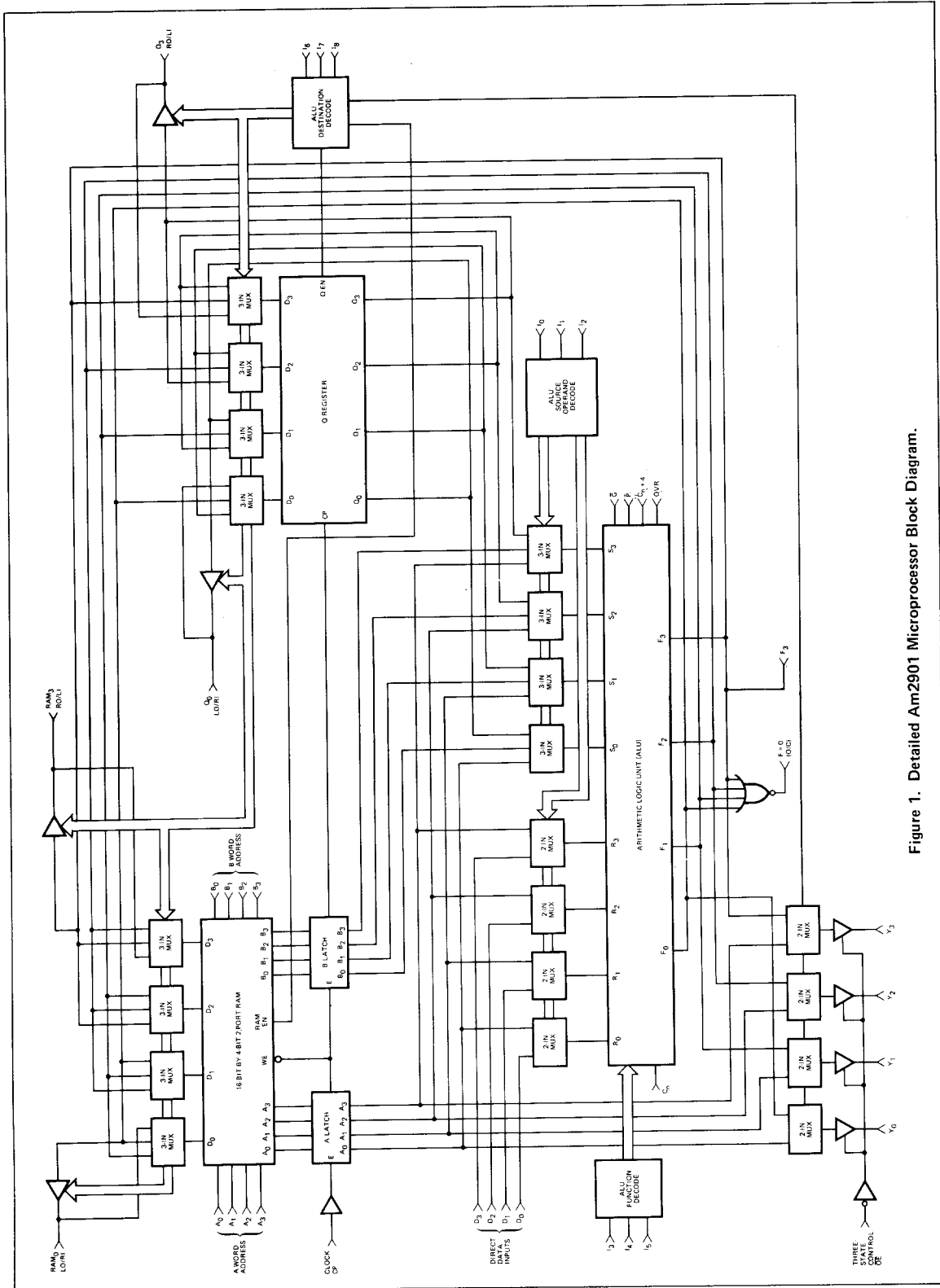

Figure 1. Detailed Am2901 Microprocessor Block Diagram.

MICRO CODE				ALU SOURCE OPERANDS	
I <sub>2</sub>	I <sub>1</sub>	I <sub>0</sub>	Octal Code	R	S
L	L	L	0	A	Q
L	L	H	1	A	B
L	H	L	2	O	Q
L	H	H	3	O	B
H	L	L	4	O	A
H	L	H	5	D	A
H	H	L	6	D	Q
H	H	H	7	D	O

Figure 2. ALU Source Operand Control.

MICRO CODE				ALU Function	Symbol
I <sub>5</sub>	I <sub>4</sub>	I <sub>3</sub>	Octal Code		
L	L	L	0	R Plus S	R + S
L	L	H	1	S Minus R	S - R
L	H	L	2	R Minus S	R - S
L	H	H	3	R OR S	R ∨ S
H	L	L	4	R AND S	R ∧ S
H	L	H	5	$\bar{R}$ AND S	$\bar{R} \wedge S$
H	H	L	6	R EX-OR S	R ∨ S
H	H	H	7	R EX-NOR S	$\bar{R} \vee S$

Figure 3. ALU Function Control.

MICRO CODE				RAM FUNCTION		Q-REG. FUNCTION		Y	RAM SHIFTER		Q SHIFTER	
I <sub>8</sub>	I <sub>7</sub>	I <sub>6</sub>	Octal Code	Shift	Load	Shift	Load	OUTPUT	RAM <sub>0</sub> LO/RI	RAM <sub>3</sub> LI/RO	Q <sub>0</sub> LO/RI	Q <sub>3</sub> LI/RO
L	L	L	0	—	—	NONE	ALU (F <sub>i</sub> )	F	X	X	X	X
L	L	H	1	—	—	—	—	F	X	X	X	X
L	H	L	2	NONE	ALU (F <sub>i</sub> )	—	—	A	X	X	X	X
L	H	H	3	NONE	ALU (F <sub>i</sub> )	—	—	F	X	X	X	X
H	L	L	4	RIGHT (DOWN)	ALU (F <sub>i+1</sub> )	RIGHT (DOWN)	Q-REG (Q <sub>i+1</sub> )	F	F <sub>0</sub>	IN <sub>3</sub>	Q <sub>0</sub>	IN <sub>3</sub>
H	L	H	5	RIGHT (DOWN)	ALU (F <sub>i+1</sub> )	—	—	F	F <sub>0</sub>	IN <sub>3</sub>	Q <sub>0</sub>	X
H	H	L	6	LEFT (UP)	ALU (F <sub>i-1</sub> )	LEFT (UP)	Q-REG (Q <sub>i-1</sub> )	F	IN <sub>0</sub>	F <sub>3</sub>	IN <sub>0</sub>	Q <sub>3</sub>
H	H	H	7	LEFT (UP)	ALU (F <sub>i-1</sub> )	—	—	F	IN <sub>0</sub>	F <sub>3</sub>	X	Q <sub>3</sub>

X = Don't care. Electrically, the shift pin is a TTL input internally connected to a three-state output which is in the high-impedance state.

Figure 4. ALU Destination Control.

OCTAL I <sub>5</sub> I <sub>4</sub> I <sub>3</sub>	OCTAL I <sub>2</sub> I <sub>1</sub> I <sub>0</sub>	ALU Source	0	1	2	3	4	5	6	7
		ALU Function	A, Q	A, B	O, Q	O, B	O, A	D, A	D, Q	D, O
0	C <sub>n</sub> = L R Plus S C <sub>n</sub> = H	A+Q	A+B	Q	B	A	D+A	D+Q	D	
		A+Q+1	A+B+1	Q+1	B+1	A+1	D+A+1	D+Q+1	D+1	
1	C <sub>n</sub> = L S Minus R C <sub>n</sub> = H	Q-A-1	B-A-1	Q-1	B-1	A-1	A-D-1	Q-D-1	-D-1	
		Q-A	B-A	Q	B	A	A-D	Q-D	-D	
2	C <sub>n</sub> = L R Minus S C <sub>n</sub> = H	A-Q-1	A-B-1	-Q-1	-B-1	-A-1	D-A-1	D-Q-1	D-1	
		A-Q	A-B	-Q	-B	-A	D-A	D-Q	D	
3	R OR S	A ∨ Q	A ∨ B	Q	B	A	D ∨ A	D ∨ Q	D	
4	R AND S	A ∧ Q	A ∧ B	0	0	0	D ∧ A	D ∧ Q	0	
5	$\bar{R}$ AND S	$\bar{A} \wedge Q$	$\bar{A} \wedge B$	Q	B	A	$\bar{D} \wedge A$	$\bar{D} \wedge Q$	0	
6	R EX-OR S	A ∨ Q	A ∨ B	Q	B	A	D ∨ A	D ∨ Q	D	
7	R EX-NOR S	A ∨ Q	$\bar{A} \vee \bar{B}$	$\bar{Q}$	$\bar{B}$	$\bar{A}$	$\bar{D} \vee \bar{A}$	$\bar{D} \vee \bar{Q}$	$\bar{D}$	

+ = Plus; - = Minus; ∨ = OR; ∧ = AND; ∨ = EX-OR

Figure 5. Source Operand and ALU Function Matrix.

## SOURCE OPERANDS AND ALU FUNCTIONS

There are eight source operand pairs available to the ALU as selected by the  $I_0$ ,  $I_1$ , and  $I_2$  instruction inputs. The ALU can perform eight functions; five logic and three arithmetic. The  $I_3$ ,  $I_4$ , and  $I_5$  instruction inputs control this function selection. The carry input,  $C_n$ , also affects the ALU results when in the arithmetic mode. The  $C_n$  input has no effect in the logic mode. When  $I_0$  through  $I_5$  and  $C_n$  are viewed together, the matrix of

Figure 5 results. This matrix fully defines the ALU/source operand function for each state.

The ALU functions can also be examined on a "task" basis, i.e., add, subtract, AND, OR, etc. In the arithmetic mode, the carry will affect the function performed while in the logic mode, the carry will have no bearing on the ALU output. Figure 6 defines the various logic operations that the Am2901 can perform and Figure 7 shows the arithmetic functions of the device. Both carry-in LOW ( $C_n = 0$ ) and carry-in HIGH ( $C_n = 1$ ) are defined in these operations.

Octal I543, I210	Group	Function
4 0 4 1 4 5 4 6	AND	$A \wedge Q$ $A \wedge B$ $D \wedge A$ $D \wedge Q$
3 0 3 1 3 5 3 6	OR	$A \vee Q$ $A \vee B$ $D \vee A$ $D \vee Q$
6 0 6 1 6 5 6 6	EX-OR	$A \vee Q$ $A \vee B$ $D \vee A$ $D \vee Q$
7 0 7 1 7 5 7 6	EX-NOR	$\overline{A \vee Q}$ $\overline{A \vee B}$ $\overline{D \vee A}$ $\overline{D \vee Q}$
7 2 7 3 7 4 7 7	INVERT	$\overline{Q}$ $\overline{B}$ $\overline{A}$ $\overline{D}$
6 2 6 3 6 4 6 7	PASS	Q B A D
3 2 3 3 3 4 3 7	PASS	Q B A D
4 2 4 3 4 4 4 7	"ZERO"	0 0 0 0
5 0 5 1 5 5 5 6	MASK	$\overline{A} \wedge Q$ $\overline{A} \wedge B$ $\overline{D} \wedge A$ $\overline{D} \wedge Q$

Figure 6. ALU Logic Mode Functions.  
( $C_n$  Irrelevant)

Octal I543, I210	$C_n = 0$ (Low)		$C_n = 1$ (High)	
	Group	Function	Group	Function
0 0 0 1 0 5 0 6	ADD	A+Q	ADD plus one	A+Q+1
		A+B		A+B+1
		D+A		D+A+1
		D+Q		D+Q+1
0 2 0 3 0 4 0 7	PASS	Q	Increment	Q+1
		B		B+1
		A		A+1
		D		D+1
1 2 1 3 1 4 2 7	Decrement	Q-1	PASS	Q
		B-1		B
		A-1		A
		D-1		D
2 2 2 3 2 4 1 7	1's Comp.	-Q-1	2's Comp. (Negate)	-Q
		-B-1		-B
		-A-1		-A
		-D-1		-D
1 0 1 1 1 5 1 6 2 0 2 1 2 5 2 6	Subtract (1's Comp)	Q-A-1	Subtract (2's Comp)	Q-A
		B-A-1		B-A
		A-D-1		A-D
		Q-D-1		Q-D
		A-Q-1		A-Q
		A-B-1		A-B
		D-A-1		D-A
		D-Q-1		D-Q

Figure 7. ALU Arithmetic Mode Functions.

**LOGIC FUNCTIONS FOR G, P, C<sub>n+4</sub>, AND OVR**

The four signals G, P, C<sub>n+4</sub>, and OVR are designed to indicate carry and overflow conditions when the Am2901 is in the add or subtract mode. The table below indicates the logic equations for these four signals for each of the eight ALU functions. The R and S inputs are the two inputs selected according to Figure 2.

**Definitions (+ = OR)**

$$\begin{aligned}
 P_0 &= R_0 + S_0 & G_0 &= R_0 S_0 \\
 P_1 &= R_1 + S_1 & G_1 &= R_1 S_1 \\
 P_2 &= R_2 + S_2 & G_2 &= R_2 S_2 \\
 P_3 &= R_3 + S_3 & G_3 &= R_3 S_3
 \end{aligned}$$

$$C_4 = G_3 + P_3 G_2 + P_3 P_2 G_1 + P_3 P_2 P_1 G_0 + P_3 P_2 P_1 P_0 C_n$$

$$C_3 = G_2 + P_2 G_1 + P_2 P_1 G_0 + P_2 P_1 P_0 C_n$$

I <sub>543</sub>	Function	$\bar{P}$	$\bar{G}$	C <sub>n+4</sub>	OVR
0	R + S	$\overline{P_3 P_2 P_1 P_0}$	$\overline{G_3 + P_3 G_2 + P_3 P_2 G_1 + P_3 P_2 P_1 G_0}$	C <sub>4</sub>	C <sub>3</sub> ∨ C <sub>4</sub>
1	S - R	← Same as R + S equations, but substitute $\bar{R}_i$ for R <sub>i</sub> in definitions →			
2	R - S	← Same as R + S equations, but substitute $\bar{S}_i$ for S <sub>i</sub> in definitions →			
3	R ∨ S	LOW	$P_3 P_2 P_1 P_0$	$\overline{P_3 P_2 P_1 P_0} + C_n$	$\overline{P_3 P_2 P_1 P_0} + C_n$
4	R ∧ S	LOW	$\overline{G_3 + G_2 + G_1 + G_0}$	$G_3 + G_2 + G_1 + G_0 + C_n$	$\overline{G_3 + G_2 + G_1 + G_0} + C_n$
5	$\bar{R} \wedge S$	LOW	← Same as R ∧ S equations, but substitute $\bar{R}_i$ for R <sub>i</sub> in definitions →		
6	R ∨ $\bar{S}$	← Same as $\bar{R} \vee S$ , but substitute $\bar{R}_i$ for R <sub>i</sub> in definitions →			
7	$\overline{R \vee S}$	$G_3 + G_2 + G_1 + G_0$	$P_3 G_3 + P_3 P_2 G_2 + P_3 P_2 P_1 G_1 + P_3 P_2 P_1 P_0$	$P_3 G_3 + P_3 P_2 G_2 + P_3 P_2 P_1 G_1 + P_3 P_2 P_1 P_0 (G_0 + C_n)$	Complement of C <sub>n+4</sub> at left

+ = OR

Figure 8.

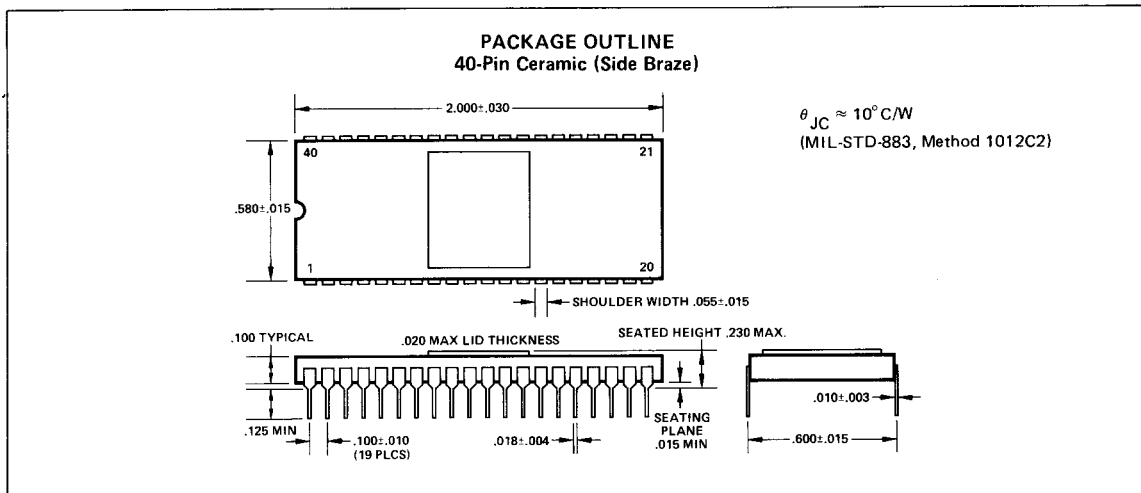

Figure 9.

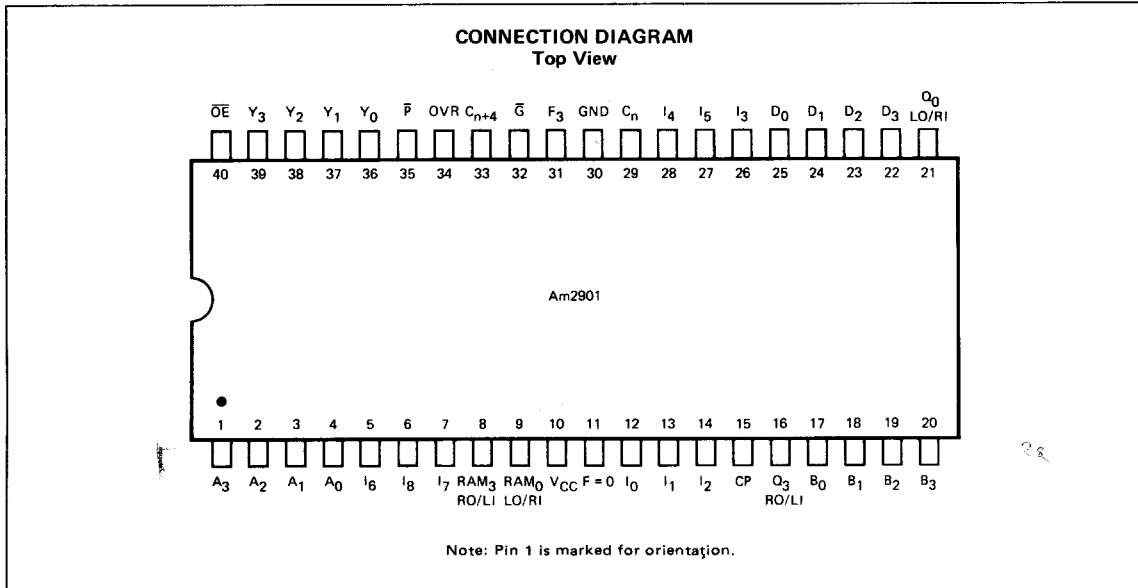

Figure 10.

**PIN DEFINITIONS**

- |                        |  |                        |   |
|------------------------|--|------------------------|---|
| <b>A<sub>0-3</sub></b> | The four address inputs to the register stack used to select one register whose contents are displayed through the A-port.   | <b>Y<sub>0-3</sub></b> | The four data outputs of the Am2901. These are three-state output lines. When enabled, they display either the four outputs of the ALU or the data on the A-port of the register stack, as determined by the destination code I <sub>678</sub> .  |
| <b>B<sub>0-3</sub></b> | The four address inputs to the register stack used to select one register whose contents are displayed through the B-port and into which new data can be written when the clock goes LOW.  | <b>OE</b>              | Output Enable. When OE is HIGH, the Y outputs are OFF; when OE is LOW, the Y outputs are active (HIGH or LOW).  |
| <b>I<sub>0-8</sub></b> | The nine instruction control lines to the Am2901, used to determine what data sources will be applied to the ALU (I <sub>012</sub> ), what function the ALU will perform (I <sub>345</sub> ), and what data is to be deposited in the Q-register or the register stack (I <sub>678</sub> ).  | <b>P, G</b>            | The carry generate and propagate outputs of the Am2901's ALU. These signals are used with the Am2902 for carry-lookahead. See Figure 8 for the logic equations.   |
| <b>RO/LI</b>           | A shift line at the MSB of the Q register (Q <sub>3</sub> RO/LI) and the register stack (RAM <sub>3</sub> RO/LI). Electrically these lines are three-state outputs connected to TTL inputs internal to the Am2901. When the destination code on I <sub>678</sub> indicates a right shift (octal 6 or 7) the three-state outputs are enabled and the MSB of the Q register is available on the Q <sub>3</sub> RO/LI pin and the MSB of the ALU output is available on the RAM <sub>3</sub> RO/LI pin. Otherwise, the three-state outputs are OFF (high-impedance) and the pins are electrically LS-TTL inputs. When the destination code calls for a down (left) shift, the pins are used as the data inputs to the MSB of the Q register (octal 4) and RAM (octal 4 or 5). | <b>OVR</b>             | Overflow. This pin is logically the Exclusive-OR of the carry-in and carry-out of the MSB of the ALU. At the most significant end of the word, this pin indicates that the result of an arithmetic two's complement operation has overflowed into the sign-bit. See Figure 8 for logic equation.  |
| <b>LO/RI</b>           | Shift lines like RO/LI, but at the LSB of the Q-register and RAM. These pins are tied to the RO/LI pin of the adjacent device to transfer data between devices for left and right shifts of the Q register and ALU data.   | <b>F = 0</b>           | This is an open collector output which goes HIGH (OFF) if the data on the four ALU outputs F <sub>0-3</sub> are all LOW. In positive logic, it indicates the result of an ALU operation is zero.  |
| <b>D<sub>0-3</sub></b> | Direct data inputs. A four-bit data field which may be selected as one of the ALU data sources for entering data into the Am2901. D <sub>0</sub> is the LSB.   | <b>C<sub>n</sub></b>   | The carry-in to the Am2901's ALU.   |
|                        |  | <b>C<sub>n+4</sub></b> | The carry-out of the Am2901's ALU. See Figure 8 for equations.  |
|                        |  | <b>CP</b>              | The clock to the Am2901. The Q register and register stack outputs change on the clock LOW-to-HIGH transition. The clock LOW time is internally the write enable to the 16 x 4 RAM which comprises the "master" latches of the register stack. While the clock is LOW, the "slave" latches on the RAM outputs are closed, storing the data previously on the RAM outputs. This allows synchronous master-slave operation of the register stack. |

**MAXIMUM RATINGS** (Above which the useful life may be impaired)

Storage Temperature	-65°C to +150°C
Temperature (Ambient) Under Bias	-55°C to +125°C
Supply Voltage to Ground Potential	-0.5 V to +6.3 V
DC Voltage Applied to Outputs for HIGH Output State	-0.5 V to +V <sub>CC</sub> max.
DC Input Voltage	-0.5 V to +5.5 V
DC Output Current, Into Outputs	30 mA
DC Input Current	-30 mA to +5.0 mA

**OPERATING RANGE**

P/N	Ambient Temperature	V <sub>CC</sub>
Am2901PC, DC	0°C to +70°C	4.75 V to 5.25 V
Am2901DM, FM	-55°C to +125°C	4.50 V to 5.50 V

**STANDARD SCREENING**  
(Conforms to MIL-STD-883 for Class C Parts)

Step	MIL-STD-883 Method	Conditions	Level	
			Am2901PC, DC	Am2901DM, FM
Pre-Seal Visual Inspection	2010	B	100%	100%
Stabilization Bake	1008	C 24-hour 150°C	100%	100%
Temperature Cycle	1010	C -65°C to +150°C 10 cycles	100%	100%
Centrifuge	2001	B 10,000 G	100% *	100%
Fine Leak	1014	A 5 x 10 <sup>-8</sup> atm-cc/cm <sup>3</sup>	100% *	100%
Gross Leak	1014	C2 Fluorocarbon	100% *	100%
Electrical Test Subgroups 1 and 7	5004	See below for definitions of subgroups	100%	100%
Insert Additional Screening here for Class B Parts				
Group A Sample Tests				
Subgroup 1	5005	See below for definitions of subgroups	LTPD = 5	LTPD = 5
Subgroup 2			LTPD = 7	LTPD = 7
Subgroup 3			LTPD = 7	LTPD = 7
Subgroup 7			LTPD = 7	LTPD = 7
Subgroup 8			LTPD = 7	LTPD = 7
Subgroup 9			LTPD = 7	LTPD = 7

\*Not applicable for Am2901PC

**ADDITIONAL SCREENING FOR CLASS B PARTS**

Step	MIL-STD-883 Method	Conditions	Level
			Am2901DMB, FMB
Burn-In	1015	D 125°C 160 hours min.	100%
Electrical Test Subgroup 1 Subgroup 2 Subgroup 3 Subgroup 7 Subgroup 9	5004		100% 100% 100% 100% 100%
Return to Group A Tests in Standard Screening			

**ORDERING INFORMATION**

Package Type	Temperature Range	Order Number
Molded DIP	0°C to +70°C	AM2901PC
Hermetic DIP	0°C to +70°C	AM2901DC
Hermetic DIP	-55°C to +125°C	AM2901DM
Hermetic Flat Pack	-55°C to +125°C	AM2901FM
Dice	0°C to +70°C	AM2901XC

**GROUP A SUBGROUPS**

(as defined in MIL-STD-883, method 5005)

Subgroup	Parameter	Temperature
1	DC	25°C
2	DC	Maximum rated temperature
3	DC	Minimum rated temperature
7	Function	25°C
8	Function	Maximum and minimum rated temperature
9	Switching	25°C
10	Switching	Maximum Rated Temperature
11	Switching	Minimum Rated Temperature



**ELECTRICAL CHARACTERISTICS OVER OPERATING RANGE** (Unless Otherwise Noted)  
(Group A, Subgroups 1, 2 and 3)

Parameters	Description	Test Conditions (Note 1)	Min.	Typ. (Note 2)	Max.	Units
$V_{OH}$	Output HIGH Voltage	$V_{CC} = \text{MIN.}$ $V_{IN} = V_{IH} \text{ or } V_{IL}$	$I_{OH} = -1.6\text{mA}$ $Y_0, Y_1, Y_2, Y_3$	2.4		Volts
			$I_{OH} = -1.0\text{mA}, C_{n+4}$	2.4		
			$I_{OH} = -800\mu\text{A}, \text{OVR}, \bar{P}$	2.4		
			$I_{OH} = -600\mu\text{A}, F_3$	2.4		
			$I_{OH} = -600\mu\text{A}$ All RO/LI, LO/RI	2.4		
			$I_{OH} = -1.6\text{mA}, \bar{G}$	2.4		
$I_{CEX}$	Output Leakage Current for F = 0 Output	$V_{CC} = \text{MIN.}, V_{OH} = 5.5\text{V}$ $V_{IN} = V_{IH} \text{ or } V_{IL}$			250	$\mu\text{A}$
$V_{OL}$	Output LOW Voltage	$V_{CC} = \text{MIN.},$ $V_{IN} = V_{IH} \text{ or } V_{IL}$	$I_{OL} = 16\text{mA}$ $Y_0, Y_1, Y_2, Y_3$		0.5	Volts
			$I_{OL} = 10\text{mA}, C_{n+4}, F = 0$		0.5	
			$I_{OL} = 8.0\text{mA}, \text{OVR}, \bar{P}$		0.5	
			$I_{OL} = 6.0\text{mA}, F_3$ All RO/LI, LO/RI		0.5	
$V_{IH}$	Input HIGH Level	Guaranteed input logical HIGH voltage for all inputs	2.0			Volts
$V_{IL}$	Input LOW Level	Guaranteed input logical LOW voltage for all inputs	Military		0.7	Volts
			Commercial		0.8	
$V_I$	Input Clamp Voltage	$V_{CC} = \text{MIN.}, I_{IN} = -18\text{mA}$			-1.5	Volts
$I_{IL}$ (Note 3)	Input LOW Current	$V_{CC} = \text{MAX.}$ $V_{IN} = 0.5\text{V}$	Clock, $\bar{OE}$		-0.36	mA
			$A_0, A_1, A_2, A_3$		-0.36	
			$B_0, B_1, B_2, B_3$		-0.36	
			$D_0, D_1, D_2, D_3$		-0.72	
			$I_0, I_1, I_2, I_6, I_8$		-0.36	
			$I_3, I_4, I_5, I_7$		-0.72	
			All LO/RI, RO/LI (Note 4)		-0.8	
			$C_n$		-3.6	
$I_{IH}$ (Note 3)	Input HIGH Current	$V_{CC} = \text{MAX.}$ $V_{IN} = 2.7\text{V}$	Clock, $\bar{OE}$		20	$\mu\text{A}$
			$A_0, A_1, A_2, A_3$		20	
			$B_0, B_1, B_2, B_3$		20	
			$D_0, D_1, D_2, D_3$		40	
			$I_0, I_1, I_2, I_6, I_8$		20	
			$I_3, I_4, I_5, I_7$		40	
			All LO/RI, RO/LI (Note 4)		100	
			$C_n$		200	
$I_I$	Input HIGH Current	$V_{CC} = \text{MAX.}, V_{IN} = 5.5\text{V}$			1.0	mA
$I_{OZ}$	Off State (High Impedance) Output Current	$V_{CC} = \text{MAX.}$	$Y_0, Y_1, Y_2, Y_3$	$V_O = 2.4\text{V}$	50	$\mu\text{A}$
				$V_O = 0.5\text{V}$	-50	
			All LO/RI, RO/LI	$V_O = 2.4\text{V}$ (Note 5)	100	
				$V_O = 0.5\text{V}$ (Note 5)	-800	
$I_{SC}$	Output Short Circuit Current (Note 4)		$Y_0, Y_1, Y_2, Y_3, \bar{G}$	-6.0	-40	mA
			$C_{n+4}$	-6.0	-40	
			$\text{OVR}, \bar{P}$	-6.0	-40	
			$F_3$	-6.0	-40	
			All RO/LI, LO/RI	-6.0	-40	
$I_{CC}$	Power Supply Current	$V_{CC} = \text{MAX.}$	Military	185	280	mA
			Commercial	185	280	

- Notes: 1. For conditions shown as MIN or MAX, use the appropriate value specified under Electrical Characteristics for the applicable device type.  
 2. Typical limits are at  $V_{CC} = 5.0\text{V}$ ,  $25^\circ\text{C}$  ambient and maximum loading.  
 3. Not more than one output should be shorted at a time. Duration of the short circuit test should not exceed one second.  
 4. LO/RI and RO/LI are three-state outputs internally connected to TTL inputs. Input characteristics are measured with  $I_{B78}$  in a state such that the three-state output is OFF.

## GUARANTEED OPERATING CONDITIONS

Tables I, II, and III below define the timing requirements of the Am2901 in a system. The Am2901 is guaranteed to function correctly over the operating range when used within the delay and set-up time constraints of these tables for the appropriate device type. The tables are divided into three types of parameters; clock characteristics, combinational delays from inputs to outputs, and set-up and hold time requirements. The latter table defines the time prior to the end of the cycle (i.e., clock LOW-to-HIGH transition) that each input must be stable to guarantee that the correct data is written into one of the internal registers.

The performance of the Am2901 within the limits of these tables is guaranteed by the testing defined as "Group A, Subgroup 9" Electrical Testing. For a copy of the tests and limits used for subgroup 9, contact Advanced Micro Devices' Product Marketing.

TABLE I

### CYCLE TIME AND CLOCK CHARACTERISTICS

TIME	Am2901DC	Am2901DM
Minimum Read-Modify-Write Cycle (time from selection of A, B registers to end of cycle)	105 ns	120 ns
Maximum Clock Frequency to Shift Q Register (50% duty cycle)	9.5 MHz	8.3 MHz
Minimum Clock LOW Time	30 ns	30 ns
Minimum Clock HIGH Time	30 ns	30 ns
Minimum Clock Period	105 ns	120 ns

TABLE II

### MAXIMUM COMBINATIONAL PROPAGATION DELAYS (all in ns, $C_L \leq 15\text{pF}$ )

From Input \ To Output	Am2901DC								Am2901DM							
	Y	F <sub>3</sub>	C <sub>n+4</sub>	$\overline{G}, \overline{P}$	F=0 R <sub>L</sub> = 470	OVR	RO, LO		Y	F <sub>3</sub>	C <sub>n+4</sub>	$\overline{G}, \overline{P}$	F=0 R <sub>L</sub> = 470	OVR	RO, LO	
							RAM	Q							RAM	Q
Clock 	115	85	100	100	110	95	105	60	125	95	110	110	120	105	115	65
A, B	110	85	80	80	110	75	110	—	120	95	90	90	120	85	120	—
D	100	70	70	70	100	60	60	—	110	80	75	75	110	65	65	—
C <sub>n</sub>	55	35	30	—	50	40	55	—	60	40	30	—	55	45	60	—
I <sub>012</sub>	85	65	65	65	80	65	80	—	90	70	70	70	85	70	85	—
I <sub>345</sub>	70	55	60	60	70	60	65	—	75	60	65	65	75	65	70	—
I <sub>678</sub>	55	—	—	—	—	—	45	45	60	—	—	—	—	—	50	50
OE Enable/Disable	40/25	—	—	—	—	—	—	—	40/25	—	—	—	—	—	—	—
A bypassing ALU (I = 2xx)	60	—	—	—	—	—	—	—	65	—	—	—	—	—	—	—

### SET-UP AND HOLD TIMES (minimum cycles from each input)

Set-up and hold times are defined relative to the clock LOW-to-HIGH edge. Inputs must be steady at all times from the set-up

time prior to the clock until the hold time after the clock. The set-up times allow sufficient time to perform the correct operation on the correct data so that the correct ALU data can be written into one of the registers.

TABLE III

### Set-Up and Hold Times (all in ns) (Note 1)

From Input	Notes	Am2901DC		Am2901DM	
		Set-Up Time	Hold Time	Set-Up Time	Hold Time
A, B Source	2, 3, 4	105 $t_{pwL} + 30$	0	120 $t_{pwL} + 30$	0
B Dest.	2, 4	$t_{pwL} + 15$	0	$t_{pwL} + 15$	0
D		100	0	110	0
C <sub>n</sub>		55	0	60	0
I <sub>012</sub>		85	0	90	0
I <sub>345</sub>		70	0	75	0
I <sub>678</sub>	4	$t_{pwL} + 15$	0	$t_{pwL} + 15$	0
RI, LI (RAM or Q)		30	0	30	0

Notes: 1. See Figure 11 and 12.

2. If the B address is used as a source operand, allow for the "A, B source" set-up time; if it is used only for the destination address, use the "B dest." set-up time.

3. Where two numbers are shown, both must be met.

4. " $t_{pwL}$ " is the clock LOW time.

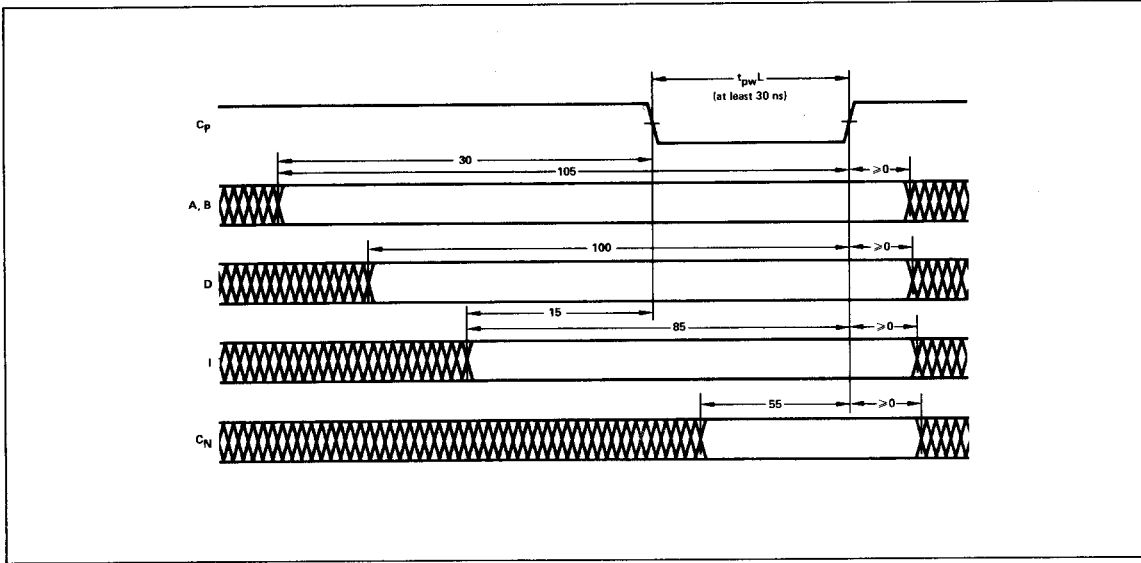
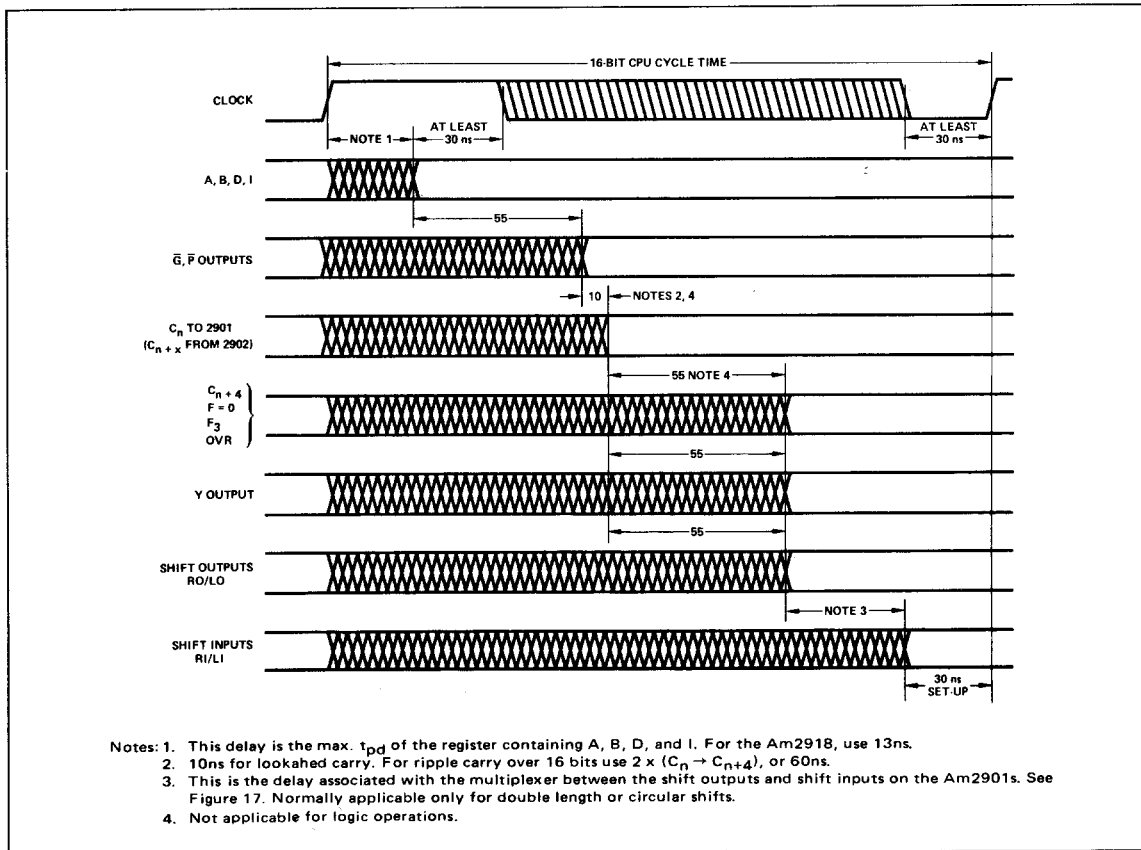

Figure 11. Minimum Cycle Times from Inputs. Numbers Shown are Minimum Data Stable Times for Am2901 DC, in ns.



- Notes: 1. This delay is the max.  $t_{pd}$  of the register containing A, B, D, and I. For the Am2918, use 13ns.  
 2. 10ns for lookahed carry. For ripple carry over 16 bits use  $2 \times (C_n \rightarrow C_{n+4})$ , or 60ns.  
 3. This is the delay associated with the multiplexer between the shift outputs and shift inputs on the Am2901s. See Figure 17. Normally applicable only for double length or circular shifts.  
 4. Not applicable for logic operations.

Figure 12. Switching Waveforms for 16-Bit System Assuming A, B, D and I are all Driven from Registers with the same Propagation Delay, Clocked by the Am2901 Clock.